



# Brewery Chillers



*It's All about Building a Better Product for Our Clients!*

J&M Fluidics, Inc. — 851 Tech Drive, Telford, PA 18969  
Toll-Free: (888) 539-1731 • Fax: 267-203-8786

Model: IEZATB12D

## Split-System, Air-Cooled 12 HP Brewery Chiller

### with Stainless Steel Tank



User-Friendly HMI Touch Screen with Protective Cover

#### STANDARD ON ALL J&M MODELS:

Pentra Microsmart, Programmable Logic Controller (PLC) with HMI Touch Screen Display.

Also comes with - Outside Condenser Model (OC12D)

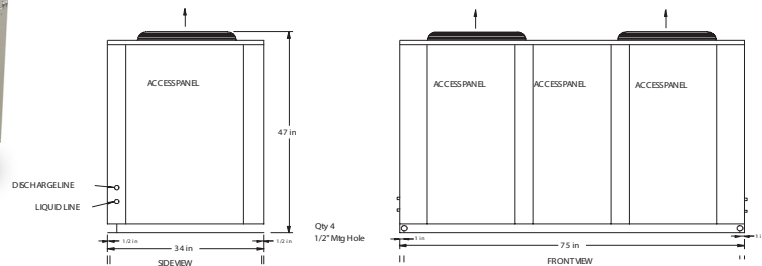

OC Refrigerant Connections: Discharge Line- 7/8", Liquid Line- 1/2"

### Standard Features:

- ETL listed to UL1995 & CAN/CSA C22.2 No. 236-11, 4th edition, 10/14/2011
- Single point power connection
- Pentra Microsmart, Programmable Logic Controller (PLC) with easy to use HMI touch screen display
- Door Mounted HMI with weather proof cover
- 5 Port Ethernet Switch (Chiller remote network access control and Modbus capability)
- Remote SMTP services for email alerts
- STAINLESS STEEL Tank
- STAINLESS STEEL Process Pump
- Pump Isolation Valves
- Fused, STAINLESS STEEL evaporator pump
- STAINLESS STEEL, brazed plate evaporator
- Scroll compressor with crankcase heater
- Suction accumulator
- Fluid flow switch
- 24V control transformer
- Direct drive condenser fan motor
- Rust resistant, high CFM, aluminum condenser fan blade
- Condenser(s): copper tube/aluminum fin
- Compressor motor contactor
- Condenser motor and control circuit fusing
- Painted (Powder Coat), galvanized sheet metal cabinet
- 1/2" insulation on all fluid and Low pressure refrigerant lines
- Liquid line drier, sight glass, solenoid, TXV
- Complete refrigerant charge from factory
- Factory Performance



Easy to Use Touch Screen Display on ALL J&M Chiller Models

Test prior to shipment

### Options:

- Remote Idec touchscreen control panel
- Industrial VPN Router
- BacNet Gateway
- Process Pump VFD Controller
- Condenser Fan VFD Controller
- Compressor VFD Controller
- 4 year extended compressor warranty
- Casters (factory mounted)
- 115 volt (rain tight) service outlet
- Non Fused Disconnect
- Phase Monitor, line voltage monitor offering protection against phase loss/reversal, unbalance and High/Low voltage
- Compressor fusing
- Compressor Sound Cover
- Flooded cond. w/receiver/head pressure control (0°F)
- Heated, flooded cond. w/receiver/head pressure control (-20°F)
- Water flow meter
- Low flow bypass
- Dual process pump with auto changeover
- Pump suction isolation valve
- Water pressure gauge set
- Copper finned condenser coil (coastal protection)
- Coastal powder coat paint protection
- E-Coat Condenser Coil (coastal protection)
- Storage tank sight glass



# Brewery Chillers



*It's All about Building a Better Product for Our Clients!*

J&M Fluidics, Inc. — 851 Tech Drive, Telford, PA 18969  
Toll-Free: (888) 539-1731 • Fax: 267-203-8786

Model: **IEZATB12D**

## Split-System, Air-Cooled 12 HP Brewery Chiller

### Product Dimensional Drawing

© Property of J&M Fluidics, Inc.

*with Stainless Steel Tank*



Also comes with - Outside Condenser Model (OC12D)

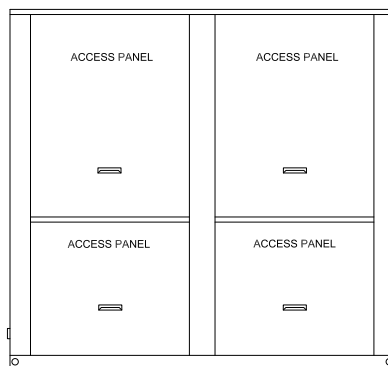
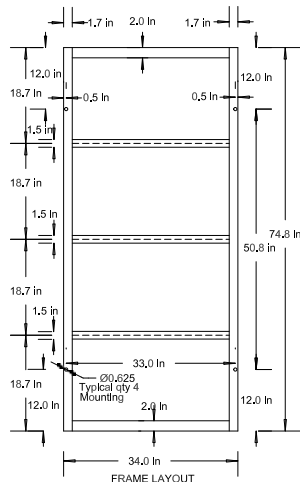

BACK VIEW

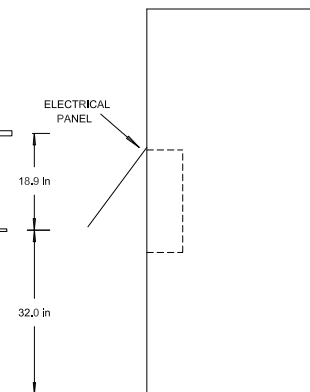

TOP VIEW

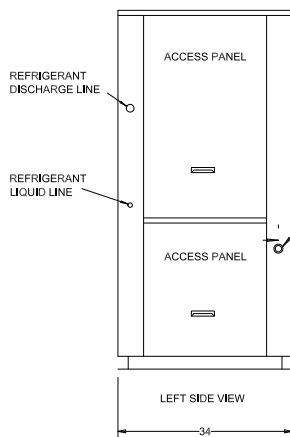

LEFT SIDE VIEW

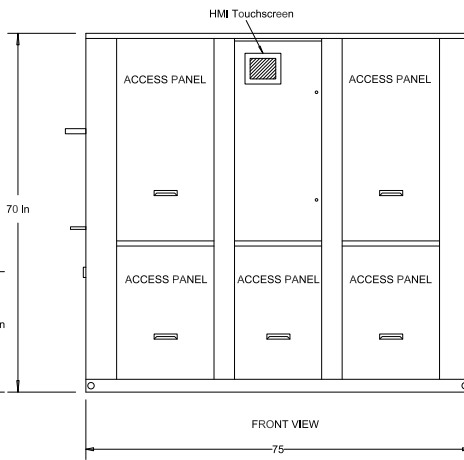

FRONT VIEW

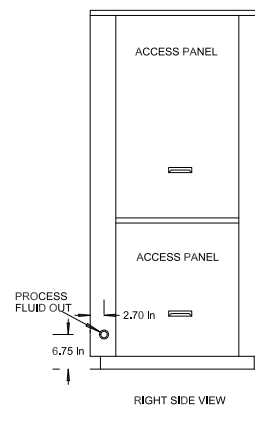

RIGHT SIDE VIEW

### Dimensional & Electrical Table (Dual Circuit)

Chiller System	Brewery Model	Capacity		Glycol Pump	Tank Capacity (Gallons)	Dimensions L x W x H (Inches)	Ship Weight (LBS)	Operating Weight (LBS)	Electrical Data			Glycol Fitting Connections Sizes
		28° F Glycol 90° Ambient	33° F Glycol 90° Ambient						Voltage / Phase / HZ	MCA	MOP	
12 HP	IEZATB12DF6	90,400	101,000	3 HP	80 Gallons	75 x 34 x 70	1475	1905	208-230 / 3 / 60	66.3	80	1 1/2"
	IEZATB12DH6								460 / 3 / 60	29.5	35	
	IEZATB12DI6								575 / 3 / 60	22.8	25	