



*It's All about Building a
Better Product for Our Clients!*

1.3 to 120 HP

Phone: (888) 539-1731

Email: info@jmchillers.com

Air-Cooled **SCROLL**

Packaged &
Split Systems
Chillers

J&M Fluidics, Inc.

is committed to serving our clients' application needs with innovative, high-quality process chillers, tank and pump skids, custom fluid cooling solutions and economizer products.

Chiller Model:
PZA26D



Chiller Model:
PZA22D



Chiller Model:
PZAT11S



Chiller Model:
PZA3S



Chiller Model:
PZA18D



Visit us at: www.jmchillers.com



TABLE OF CONTENTS

J&M Fluidics, Inc.
851 Tech Drive
Telford, PA 18969

Due to J&M Fluidics policy of continuous product improvement, J&M reserves the right to make changes without notice. Concept drawings in this booklet are representations of the equipment shown. Contact the factory for specific unit drawings.

© 2016 J&M Fluidics Inc.
All rights reserved.

Typical J&M Chiller Applications.....	2
Company Mission and Capabilities	3
Nomenclature and Selection Procedure.....	4
1S - 11S Chillers - Capacity Table	5
7D - 52D Chillers - Capacity Table	6
Idec PLC Controller Features.....	7
Idec PLC Controller Features.....	8
Packaged and Split system Chiller Features and Options	9
PZA - Single Circuit Dimensional and Electrical Specifications	10
PZA - Dual Circuit Dimensional and Electrical Specifications.....	11
PZAT - Dimensional and Electrical Specifications	12
IEZA - Single Circuit Dimensional and Electrical Specifications	13
IEZA - Dual Circuit Dimensional and Electrical Specifications.....	14
IEZAT - Single Circuit Dimensional and Electrical Specifications	15
IEZAT - Dual Circuit Dimensional and Electrical Specifications.....	16
OC - Dimensional Specifications.....	17
Tank Section - Dimensional Specifications, Features and Options.....	18
PZA & PZAT Concept Drawings.....	19
Glycol Factor Tables (Back Cover).....	20

*Our reputation is built on our commitment to excellence, advanced controls, user-friendly touch screen interface and our ability to **custom build units** exactly matched to your process application. **Your Satisfaction is what Drives Us!***

TYPICAL J&M CHILLER APPLICATIONS

Commercial, Industrial & Residential Cooling Applications

- Air Conditioning
- Oil
- Injection Molding
- Plating Process
- Welding Machine
- Computer Room Air Conditioning
- Laser
- Dry Cleaning Machine
- Jacket Cooling
- Water-Cooled Condenser
- Printing Processing
- Swimming Pools
- Aquariums
- Fish Hatcheries
- Ice skating Rinks
- Commercial Ship Cooling Applications
- Low Temperature Process
- Plastics & Rubber Industries
- Military
- Anodizing Process Cooling
- Semiconductor Cooling
- Chemical
- Energy
- Plasma Cooling
- Data Center Cooling
- Cold Storage
- Extrusion Cooling
- Custom Cooling Innovation

Food & Beverage Industry Applications

- Bakery Processing
- Brewery
- Winery
- Drinking Water Fountain
- Batch Cooling
- Ice Machine Pre-Cool
- Fruit and Vegetable Washing and Processing
- Candy Manufacturing
- Dairy Cooling
- Soft Drink/Beverage Cooling

Medical & Pharmaceutical Applications

- M.R.I. Imager Cooling
- Operating Room Air Conditioning
- P.E.T. Scan
- C.A.T. Scan
- Lab Cooling
- Hypothermia Pads and Blankets
- Pharmaceutical Process Cooling

**Have Questions...
Give Us a Call,
We are Here to Help!**



Dairy Cooling / Beverage Cooling



Winery & Brewery Process Cooling



Lab Cooling



M.R.I. Imager Cooling



Aquariums



Laser Cooling



Ice Skating Rinks

COMPANY MISSION AND CAPABILITIES

J&M Fluidics Mission...

Our Mission is to Build the Best Equipment for Our Customers' Needs and Requirements. The J&M Fluidics Label on Our Chillers Stands for **Our Commitment to Excellence**. Our Business is Built on Outstanding After-the-Sale Technical Support and Friendly Customer Service. J&M Fluidics offers quality process fluid chillers built in the U.S. by Americans that are designed, manufactured, and delivered by quality people.



J&M Fluidics, Inc. is committed to serving our clients' application needs with innovative, high-quality process chillers, tank and pump skids, custom fluid cooling solutions and economizer products. Our products are built to support a large variety of applications with a diverse product line.

What We Build:

- Air-Cooled Scroll Process Chillers
- Air-Cooled Digital Scroll Process Chillers
- Air-Cooled Semi-Hermetic Process Chillers
- Portable Air & Water-Cooled Process Chillers
- Water-Cooled Scroll Process Chillers
- Water-Cooled Semi-Hermetic Process Chillers
- Custom / OEM / Private Label Process Chillers
- Tank & Pump Packages
- City Water Change-Over Panels

Air-Cooled
Scroll Packaged Chillers



Custom Chillers

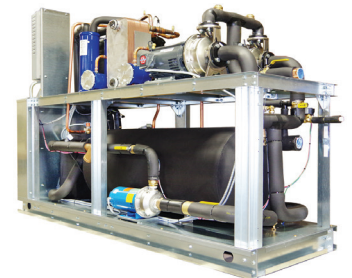

Water-Cooled
Semi-Hermetic Chillers

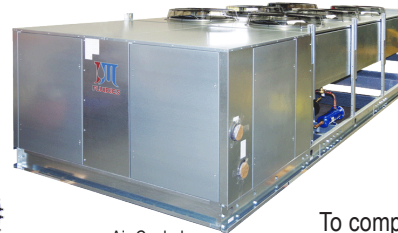
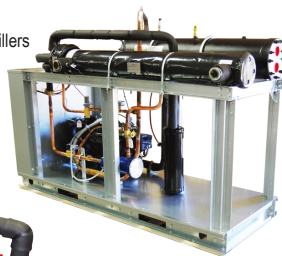

Air-Cooled
Semi-Hermetic Chillers

To compliment our complete line of standard products that J&M Fluidics Inc. offers, we also have the ability and resources to **custom design** and build equipment to a customers specific needs. **Please contact the factory or your J&M Fluidics representative for a special application.**

PZA22DF5
Air-Cooled Chiller



J&M Fluidics offers "E-Coated" Condenser Coils for Exceptional Protection Against Corrosive Environments.



J&M Fluidics
1100 Gallon
(Polyethylene) Dual
Process Pump Package
with VFD Controllers



J&M Fluidics offers **Remote Access...** Complete Touchscreen Control of the Chiller from anywhere in Your Facility.

We also offer **Custom Color and Private Label Chillers**



City Water Change-Over Panels for Extra Cooling Protection for Your Process.



NOMENCLATURE

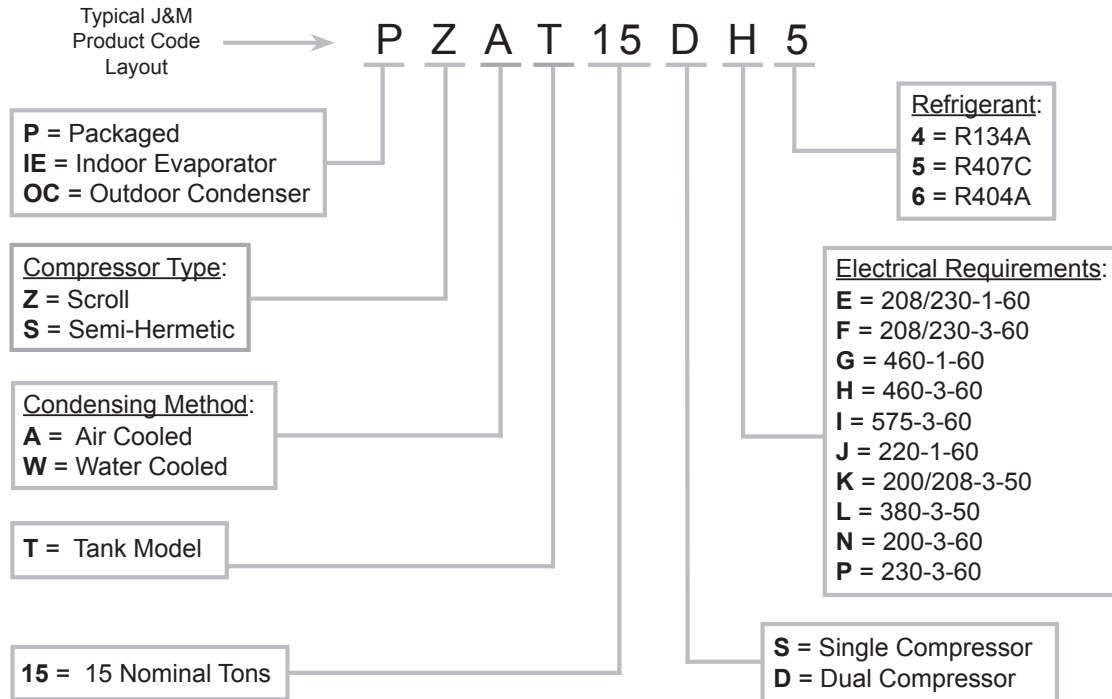

HOW TO PROPERLY SELECT AN AIR-COOLED PACKAGED CHILLER...

Caution



Low ambient, or lower leaving water temperatures, can require the recirculation of glycol solutions or other fluid blends.

These solutions can effect unit capacities.

Please consult the factory on these or other special applications for proper chiller and component sizing.

To properly select an Air-Cooled Packaged Chiller, the following information must be known:

1. The required cooling capacity, BTUH.
2. Delta T of entering and leaving fluid temperatures.
3. Fluid factor (ex. water = 500).
4. GPM of process fluid to be circulated.
5. Design ambient air temperature.



If you know any three of the above items 1 through 4 above, you can calculate the fourth by using the formulas below.

For 100% water:

- Cooling capacity (in BTUH) = GPM x Delta T x 500
- GPM = Capacity (in BTUH) / Delta T x 500
- Delta T = Capacity (in BTUH) / GPM x 500

Sample selection:

Select an air-cooled, packaged chiller to cool 9.8 GPM of 100% water from 54°F to 44°F. Design ambient air temperature 95°F. **Find:** Air-cooled chiller model.

Solution:

1. Chilled fluid Delta T = 54°F - 44°F = 10°F
2. Capacity (in BTUH) = 9.8 GPM x 10°F Delta T x 500 = 49,000 BTUH
3. From the PZA chiller capacity tables, it can be determined that the PZA4S has the capacity to meet the requirements.

Need Help... Just Give Us a Call... We are Here to Help!



1S - 11S Scroll Chillers

Model	Compressor	LWT °F	80°F			90°F			95°F			100°F			105°F		
			TONS	KW	EER	TONS	KW	EER	TONS	KW	EER	TONS	KW	EER	TONS	KW	EER
1S	ZR16K5E	42.0	1.2	1.2	7.5	1.2	1.3	6.8	1.1	1.4	6.3	1.1	1.4	6.0	1.1	1.5	5.6
		44.0	1.3	1.2	7.7	1.2	1.3	6.9	1.2	1.4	6.5	1.1	1.4	6.2	1.1	1.5	5.8
		45.0	1.3	1.2	7.8	1.2	1.3	7.0	1.2	1.4	6.6	1.2	1.4	6.3	1.1	1.5	5.9
		50.0	1.4	1.2	8.4	1.3	1.3	7.5	1.3	1.4	7.1	1.3	1.5	6.7	1.2	1.6	6.3
1.5S	ZS15KAE	42.0	1.8	1.7	8.9	1.7	1.8	7.9	1.7	1.9	7.4	1.6	2.0	7.0	1.6	2.2	6.5
		44.0	1.9	1.7	9.1	1.8	1.9	8.1	1.8	2.0	7.6	1.7	2.1	7.2	1.7	2.2	6.7
		45.0	1.9	1.7	9.3	1.8	1.9	8.3	1.8	2.0	7.7	1.7	2.1	7.3	1.7	2.2	6.8
		50.0	2.1	1.8	9.9	2.0	1.9	8.8	1.9	2.0	8.3	1.9	2.1	7.8	1.8	2.2	7.3
2S	ZS19KAE	42.0	2.0	1.9	9.7	1.9	2.1	8.6	1.9	2.2	8.1	1.8	2.3	7.6	1.8	2.4	7.1
		44.0	2.1	1.9	10.0	2.0	2.1	8.9	1.9	2.2	8.4	1.9	2.3	7.9	1.9	2.4	7.4
		45.0	2.2	1.9	10.2	2.1	2.1	9.1	2.0	2.2	8.5	2.0	2.3	8.0	1.9	2.5	7.5
		50.0	2.4	1.9	10.9	2.2	2.1	9.7	2.2	2.3	9.2	2.1	2.4	8.6	2.0	2.5	8.1
2.5S	ZS26KAE	42.0	3.0	2.8	10.4	2.8	3.1	9.1	2.7	3.3	8.4	2.7	3.5	7.9	2.6	3.7	7.3
		44.0	3.1	2.8	10.6	2.9	3.2	9.3	2.9	3.4	8.7	2.8	3.5	8.2	2.7	3.7	7.6
		45.0	3.2	2.9	10.8	3.0	3.2	9.5	2.9	3.4	8.8	2.8	3.5	8.3	2.7	3.7	7.7
		50.0	3.3	2.9	11.4	3.2	3.3	10.0	3.1	3.5	9.3	3.1	3.6	8.8	3.0	3.8	8.2
3S	ZS29KAE	42.0	3.3	3.4	10.3	3.2	3.8	9.2	3.0	3.9	8.6	3.0	4.1	8.1	2.9	4.3	7.6
		44.0	3.5	3.5	10.6	3.3	3.8	9.4	3.1	4.0	8.8	3.1	4.1	8.4	3.0	4.4	7.8
		45.0	3.6	3.5	10.8	3.4	3.8	9.6	3.2	4.0	9.0	3.2	4.2	8.5	3.1	4.4	7.9
		50.0	3.8	3.6	11.4	3.6	3.9	10.2	3.4	4.1	9.6	3.4	4.3	9.1	3.3	4.5	8.5
4S	ZB38KCE	42.0	4.2	4.0	10.9	4.0	4.4	9.5	3.9	4.6	8.9	3.8	4.8	8.3	3.7	5.1	7.7
		44.0	4.4	4.0	11.2	4.2	4.4	9.8	4.1	4.6	9.2	3.9	4.9	8.6	3.8	5.1	8.0
		45.0	4.5	4.0	11.3	4.3	4.4	9.9	4.2	4.7	9.3	4.0	4.9	8.7	3.9	5.2	8.1
		50.0	4.9	4.2	12.1	4.7	4.6	10.6	4.5	4.8	10.0	4.4	5.0	9.4	4.3	5.3	8.7
4.5S	ZB42KCE	42.0	4.8	4.3	11.2	4.6	4.8	9.7	4.4	5.1	9.0	4.3	5.4	8.4	4.2	5.8	7.7
		44.0	5.0	4.4	11.5	4.7	4.9	10.0	4.6	5.2	9.2	4.5	5.5	8.6	4.4	5.9	7.9
		45.0	5.1	4.4	11.6	4.8	4.9	10.1	4.7	5.2	9.3	4.6	5.5	8.7	4.5	5.9	8.0
		50.0	5.5	4.6	12.3	5.3	5.1	10.7	5.1	5.4	9.8	5.0	5.5	9.2	4.8	6.1	8.5
5S	ZB45KCE	42.0	5.4	4.6	12.0	5.1	5.1	10.5	5.0	5.4	9.7	4.9	5.7	9.1	4.7	6.0	8.4
		44.0	5.6	4.6	12.3	5.3	5.2	10.7	5.2	5.4	10.0	5.0	5.7	9.3	4.9	6.1	8.6
		45.0	5.7	4.7	12.5	5.4	5.2	10.9	5.3	5.5	10.1	5.2	5.8	9.4	5.0	6.1	8.7
		50.0	6.2	4.8	13.2	5.9	5.3	11.6	5.7	5.6	10.7	5.6	5.9	10.0	5.4	6.2	9.3
7S	ZB58KCE	42.0	7.0	5.9	11.1	6.6	6.6	9.8	6.4	6.9	9.1	6.3	7.3	8.5	6.1	7.7	8.0
		44.0	7.2	6.0	11.4	6.8	6.6	10.0	6.7	7.0	9.4	6.5	7.3	8.8	6.3	7.7	8.2
		45.0	7.3	6.0	11.6	6.9	6.7	10.2	6.8	7.0	9.6	6.6	7.4	9.0	6.5	7.8	8.4
		50.0	7.9	6.2	12.3	7.6	6.8	10.8	7.3	7.2	10.2	7.2	7.5	9.6	7.1	7.9	9.0
8S	ZB66KCE	42.0	7.9	7.1	10.9	7.5	7.8	9.7	7.3	8.2	9.1	7.2	8.6	8.5	7.0	9.0	8.0
		44.0	8.1	7.2	11.2	7.8	7.9	9.9	7.6	8.3	9.3	7.4	8.6	8.8	7.3	9.1	8.2
		45.0	8.3	7.2	11.4	7.9	7.9	10.1	7.8	8.3	9.5	7.6	8.7	8.9	7.4	9.1	8.4
		50.0	8.9	7.4	12.0	8.6	8.1	10.7	8.4	8.5	10.1	8.3	8.8	9.6	8.1	9.3	8.9
9S	ZB76KCE	42.0	9.0	8.4	10.8	8.6	9.2	9.6	8.4	9.7	9.0	9.0	10.1	8.4	8.0	10.6	7.9
		44.0	9.3	8.5	11.1	8.9	9.3	9.8	8.7	9.7	9.2	8.5	10.2	8.7	8.3	10.7	7.2
		45.0	9.5	8.6	11.3	9.1	9.3	10.0	8.9	9.8	9.4	8.7	10.3	8.9	8.5	10.7	7.3
		50.0	10.3	8.7	12.0	9.8	9.5	10.7	9.6	10.0	10.0	9.4	10.5	9.4	9.2	10.9	7.9
11S	ZB95KCE	42.0	10.5	9.1	11.9	10.0	10.0	10.4	9.7	10.5	9.7	9.5	11.1	9.1	9.2	11.7	8.4
		44.0	10.8	9.2	12.2	10.3	10.1	10.7	10.1	10.6	9.9	9.8	11.2	9.3	9.5	11.8	8.6
		45.0	11.0	9.2	12.4	10.5	10.2	10.8	10.3	10.7	10.0	10.0	11.2	9.4	9.7	11.9	8.7
		50.0	11.9	9.5	13.0	11.3	10.4	11.4	11.1	11.0	10.7	10.8	11.5	10.0	10.5	12.1	9.3

1. Capacities on this chart are based on refrigerant R407C. Lower leaving water or low ambient can require the use of a glycol solution or other fluid blends. These solutions affect unit capacities. Please consult the factory on these or other special fluids.
2. KW input is for compressor(s) only.
3. EER = Energy Efficiency Ratio (BTU/watt-hour). Power inputs include compressor (s), condenser fan motor (s) and control power.



7D - 52D Scroll Chillers

Model	Compressor	LWT °F	80°F			90°F			95°F			100°F			105°F		
			TONS	KW	EER	TONS	KW	EER	TONS	KW	EER	TONS	KW	EER	TONS	KW	EER
7D	ZS29KAE	42.0	7.1	7.1	9.8	6.8	7.8	8.7	6.6	8.2	8.2	6.5	8.5	7.7	6.3	8.9	7.2
		44.0	7.4	7.2	10.1	7.0	7.9	9.0	6.9	8.3	8.5	6.7	8.6	7.9	6.5	9.0	7.5
		45.0	7.5	7.3	10.3	7.2	7.9	9.1	7.0	8.3	8.6	6.8	8.7	8.0	6.7	9.1	7.6
		50.0	8.1	7.4	10.9	7.8	8.1	9.7	7.6	8.4	9.1	7.4	8.8	8.6	7.2	9.2	8.1
9D	ZB38KCE	42.0	8.8	7.8	11.4	8.3	8.5	10.0	8.1	8.9	9.3	7.9	9.4	8.6	7.7	9.9	8.1
		44.0	9.2	7.8	11.7	8.7	8.6	10.3	8.5	9.0	9.6	8.2	9.5	9.0	8.0	10.0	8.4
		45.0	9.3	7.9	11.9	8.9	8.7	10.4	8.7	9.1	9.8	8.4	9.6	9.1	8.2	10.0	8.5
		50.0	10.2	8.1	12.6	9.7	8.9	11.2	9.4	9.3	10.4	9.2	9.8	9.8	9.0	10.3	9.2
9.5D	ZB42KCE	42.0	9.8	8.4	11.8	9.3	9.4	10.2	9.1	9.9	9.5	8.8	10.5	8.8	8.6	11.2	8.1
		44.0	10.2	8.5	12.1	9.7	9.5	10.5	9.4	10.1	9.7	9.2	10.6	9.0	8.9	11.3	8.3
		45.0	10.3	8.6	12.3	9.8	9.6	10.6	9.6	10.1	9.9	9.3	10.7	9.2	9.1	11.4	8.4
		50.0	11.2	8.9	13.0	10.7	9.8	11.3	10.5	10.4	10.5	10.2	11.0	9.8	9.9	11.7	9.0
10D	ZB45KCE	42.0	10.6	9.2	12.0	10.2	10.2	10.5	10.0	10.7	9.7	9.7	11.3	9.1	9.5	11.9	8.4
		44.0	11.1	9.3	12.3	10.6	10.3	10.7	10.3	10.8	10.0	10.1	11.4	9.4	9.8	12.0	8.7
		45.0	11.4	9.4	12.5	10.8	10.4	10.9	10.6	10.9	10.2	10.3	11.5	9.5	10.1	12.1	8.8
		50.0	12.3	9.7	13.2	11.8	10.7	11.6	11.4	11.2	10.8	11.2	11.7	10.1	10.9	12.4	9.4
13D	ZB58KCE	42.0	13.9	11.8	12.5	13.2	13.1	10.8	12.9	13.8	10.1	12.6	14.5	9.4	12.3	15.3	8.7
		44.0	14.4	11.9	12.8	13.7	13.2	11.2	13.4	13.9	10.4	13.1	14.6	9.7	12.8	15.4	9.0
		45.0	14.6	12.0	13.0	14.0	13.3	11.3	13.7	14.0	10.6	13.3	14.7	9.8	13.0	15.5	9.2
		50.0	15.7	12.3	13.7	15.2	13.6	12.0	14.7	14.3	11.2	14.4	15.0	10.5	14.0	15.8	9.8
15D	ZB66KCE	42.0	15.3	14.0	11.8	14.6	15.5	10.3	14.3	16.2	9.7	13.9	17.1	9.0	13.5	17.9	8.4
		44.0	16.3	14.3	12.3	15.5	15.7	10.8	15.2	16.5	10.1	14.8	17.3	9.4	14.5	18.2	8.8
		45.0	16.5	14.4	12.5	15.8	15.8	10.9	15.5	16.6	10.3	15.2	17.4	9.6	14.8	18.3	8.9
		50.0	17.8	14.8	13.2	17.1	16.2	11.6	16.8	17.0	10.8	16.4	17.8	10.2	16.0	18.7	9.5
18D	ZB76KCE	42.0	17.9	16.8	11.7	17.2	18.5	10.3	16.9	19.4	9.7	16.4	20.3	9.0	16.0	21.4	8.4
		44.0	18.5	17.0	12.0	17.7	18.7	10.5	17.3	19.6	9.8	17.0	20.6	9.2	16.5	21.6	8.6
		45.0	18.9	17.1	12.1	18.1	18.8	10.7	17.7	19.7	10.0	17.3	20.7	9.4	16.9	21.7	8.7
		50.0	20.3	17.6	12.8	19.5	19.3	11.3	19.0	20.3	10.4	18.7	21.2	9.9	18.2	22.2	9.2
22D	ZB95KCE	42.0	20.9	18.0	12.0	20.0	19.8	10.5	19.4	20.8	9.8	18.9	21.8	9.2	18.5	23.0	8.5
		44.0	21.7	18.2	12.3	20.7	20.0	10.7	20.1	21.0	10.0	19.7	22.0	9.4	19.2	23.2	8.8
		45.0	22.1	18.2	12.5	21.0	20.1	10.9	20.5	21.1	10.2	20.0	22.2	9.6	19.6	23.3	8.9
		50.0	23.8	18.8	13.1	22.8	20.6	11.6	22.1	21.6	10.8	21.7	22.6	10.2	21.3	23.7	9.5
26D	ZB114KCE	42.0	26.0	23.4	10.9	24.8	26.0	9.5	24.2	27.5	8.9	23.7	28.9	8.3	23.0	30.5	7.7
		44.0	26.7	23.5	11.2	25.2	26.2	9.7	24.9	27.6	9.1	24.3	29.1	8.5	23.7	30.7	7.9
		45.0	27.2	23.6	11.3	25.9	26.3	9.9	25.3	27.7	9.2	24.8	29.2	8.6	24.1	30.8	8.0
		50.0	29.1	23.9	12.0	27.8	26.6	10.5	27.1	28.1	9.7	26.5	29.5	9.1	25.8	31.1	8.5
35D	ZR250KCE	42.0	35.4	33.0	10.7	33.9	36.1	9.5	33.3	37.8	8.9	32.5	39.5	8.4	31.7	41.6	7.8
		44.0	36.7	33.3	11.0	35.1	36.5	9.7	34.4	38.3	9.1	33.7	39.9	8.6	32.9	42.0	8.0
		45.0	37.3	33.5	11.1	35.8	36.8	9.8	35.0	38.5	9.2	34.3	40.1	8.7	33.3	42.2	8.1
		50.0	40.3	34.5	11.7	38.7	37.8	10.4	37.8	39.5	9.8	37.2	41.0	9.3	36.3	43.2	8.6
43D	ZR300KCE	42.0	42.8	37.7	11.5	41.1	41.4	10.2	40.2	43.4	9.6	39.3	45.4	9.0	38.4	47.7	8.4
		44.0	44.2	38.1	11.8	42.5	41.8	10.5	41.6	43.7	9.8	40.8	45.8	9.3	39.8	48.1	8.7
		45.0	45.0	38.3	11.9	43.3	42.0	10.6	42.3	44.0	10.0	41.4	46.0	9.4	40.4	48.3	8.8
		50.0	48.8	39.4	12.6	46.8	43.0	11.2	45.8	44.9	10.6	44.9	46.8	10.0	43.8	49.2	9.4
52D	ZR380KCE	42.0	53.3	48.4	11.9	49.8	53.2	10.1	48.0	56.1	9.4	48.2	58.8	8.9	44.2	61.5	8.2
		44.0	55.7	49.1	12.1	52.1	54.1	10.3	50.2	56.7	9.6	49.2	59.3	9.0	46.2	62.0	8.4
		45.0	57.0	49.0	12.3	53.3	54.5	10.4	51.3	56.9	9.7	49.3	59.5	9.1	47.3	62.2	8.5
		50.0	63.3	50.5	12.9	59.3	55.5	11.0	57.2	58.4	10.4	55.0	59.9	9.8	52.8	63.4	9.1

1. Capacities on this chart are based on refrigerant R407C. Lower leaving water or low ambient can require the use of a glycol solution or other fluid blends. These solutions affect unit capacities. Please consult the factory on these or other special fluids.
2. KW input is for compressor(s) only.
3. EER = Energy Efficiency Ratio (BTU/watt-hour). Power inputs include compressor (s), condenser fan motor (s) and control power.

Packaged & Split System Air-Cooled Chillers

Standard Features (All Models):

- ETL listed to UL1995 & CAN/CSA C22.2 No. 236-11, 4th edition, 10/14/2011
- Single point power connection
- Idec microprocessor controller with easy to use touch screen display
- **STAINLESS STEEL**, brazed plate evaporator
- Scroll compressor with crankcase heater
- Suction accumulator
- Water flow switch
- Hot gas by-pass capacity control
- 24V control transformer
- Direct drive condenser fan motor
- Rust resistant, high CFM, aluminum condenser fan blade
- Condenser(s): copper tube/aluminum fin
- Compressor motor contactor
- Condenser motor and control circuit fusing
- Painted (Powder Coated), galvanized sheet metal cabinet
- 1/2" insulation on all water and Low pressure refrigerant lines
- Liquid line drier, sight glass, solenoid, TXV
- Complete refrigerant charge from factory

Tank Models Only:

- **STAINLESS STEEL** storage tank with 1/2" insulation
- Fused, **STAINLESS STEEL** re-circulation pump for tank operation with ball valve and cleanable strainer
- Tank pressure relief valve, vent and drain hose bibs

Split System Models Only:

- Outdoor Condenser Section
- Discharge and Liquid Line ball valves on indoor and outdoor equipment



Idec Touchscreen



Brazed Plate Evaporator



Hot Gas By-Pass Capacity Control



Suction Accumulator

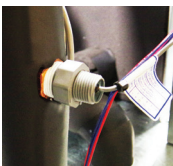

Water Flow Switch

Available Options (All Models):

- Remote Idec touchscreen control panel
- Industrial VPN Router
- 5 Port Ethernet Switch
- BacNet Gateway
- Pump VFD controller
- 4 year extended compressor warranty
- Casters (factory mounted)
- 115 volt (rain tight) service outlet
- Non Fused disconnect
- Phase monitor, line voltage monitor offering protection against phase loss/reversal, unbalance and hi/lo voltage
- Compressor fusing
- Fan cycle control (+40°F)
- Flooded condenser with receiver/ head pressure control (0°F)
- Heated, flooded condenser with receiver/ head pressure control (-20°F)
- Factory installed evaporator heat tape freeze protection
- Low flow by-pass valve
- Fused, **STAINLESS STEEL** process pump
- Dual system pump with manual changeover
- Dual system pump with auto changeover
- Pump suction isolation valve
- Water pressure gauge set
- Water flow meter
- Copper finned condenser coil (coastal protection)
- E-Coat condenser coil (coastal protection)
- Water flow meter
- Auto city water make up solenoid
- Auto city water changeover panel with filter
- Stainless steel, SCH80 PVC or Polypropylene piping for deionized and reverse osmosis water systems

Tank Models Only:

- Storage Tank Sight Glass
- Tank low liquid level indicator



Remote Idec Control Panel



5 Port Ethernet Switch



BacNet Gateway



VFD Controller



Industrial VPN Router



Disconnect Switch

J&M - Touch Screen User Interface



Touch Screen Key Chiller Control Features:

- USB update slot for IN-PLACE HMI and PLC software updates available from jmchillers.com
- Free Software Upgrades
- CE, UL Listed
- Monitor / Control your chiller from anywhere*
- 4gb SD card in slot for data storage - Standard
- Ultra bright display screen with auto screen saver
- Real-time Pressure and Temperature readings
- Automatic COMPRESSOR Lag/Lead with FIVE operational modes
- Automatic SYSTEM PUMP Lag/Lead with FIVE operational modes
- Factory configured for ALL J&M's chiller options

(Inside Mounted)
Touchscreen
Control Panel for
Outside Chillers



(PLC)
Pentra Logic
Controller

(Outside Mounted)
Touchscreen
Control Panel for
Indoor Chillers



*Some network configuration required.

Other Touchscreen User Interface Examples...

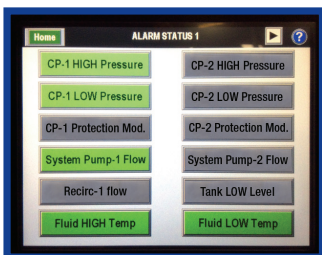

Alarm Status Screen 1

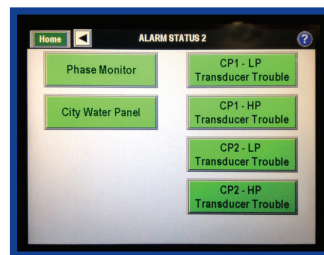

Alarm Status Screen 2

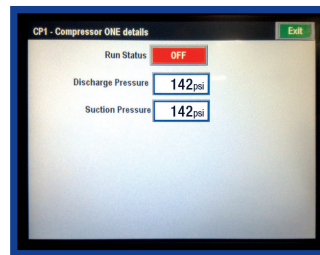

Compressor Operation Status and Pressures

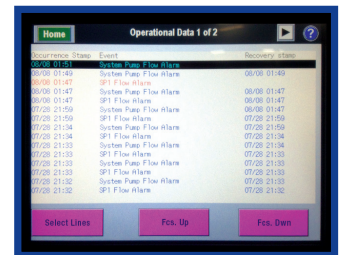

Operational Data and Fault Log

J&M - Pentra Microsmart, Programable Logic Controller (PLC)

Best-In-Class PLC available for ALL J&M production chiller models.

Factory installed and programmed into your next J&M Process Chiller. The **Pentra PLC** will seamlessly interface with our HMI touch screen.

Pentra Key features include:

- CE, UL Listed
- Highly accurate and fast performance
- Embedded Ethernet Port
- Modbus (Slave) TCP, RTU and ASCII for integration with most Building Automation Systems (BAS)
- Optional BacNet and LONWORKS communication protocols via third party gateway hardware
- Expandable I/O, ideal for custom chiller control projects
- I/O status indicators on for easy diagnostics

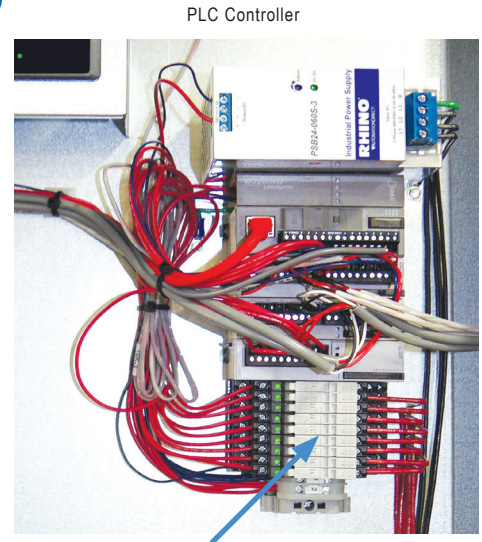

“Plugin” Control Relays for quick easy replacement. No circuit board to replace. Less downtime and cost.

Offering Extended Connectivity Options...

Up to 14 Simultaneous Connections!

Using Maintenance Communication Server connections, up to 3 Client devices, such as OI touchscreen, WindLDR software and SCADA OPC server such as WindSRV (KepServerEx), can simultaneously communicate with your MicroSmart Pentra PLC. Using Server Connections, an additional 8 connections can be established and each connection can be defined as Maintenance, User Communication or Modbus TCP server protocol. On top of that, another 3 connections can be configured as Modbus TCP client protocol, with a maximum of 255 requests. Each request can be for different slave devices with different IP addresses on the network.

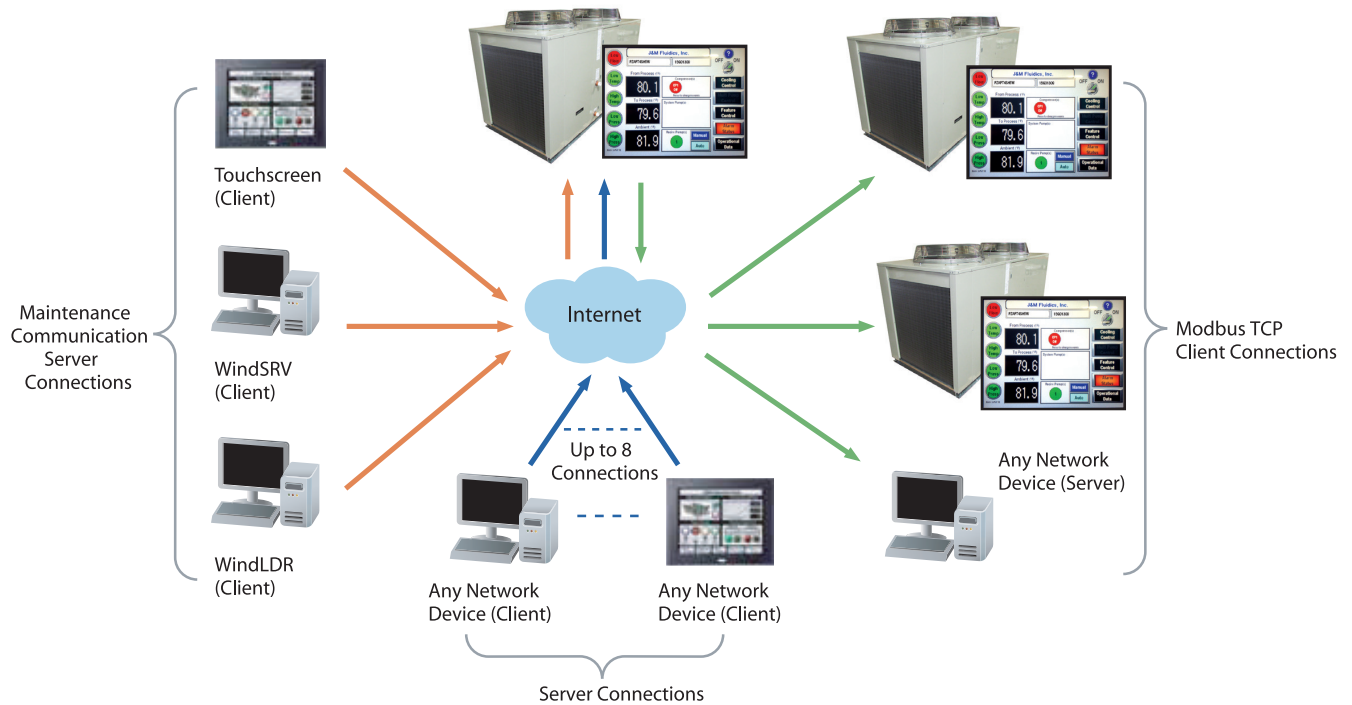

IMPORTANT CONSIDERATION: J&M offers an optional Level 3 managed switch allowing MODBUS connectivity to the Pentra MicroSmart PLC controller. In most cases, end users firewall settings will need to be updated to allow remote WAN connectivity. J&M Fluidics can provide fee based network support for special Level 3 switch configuration.



Single Circuit Packaged, Air-Cooled Chillers

Chiller Model	BTUH 95°F Air 45°F LWT	Length Inches	Width Inches	Height Inches	Compressor		RLA ea.	LRA ea.	Fan Motor		MCA	M.O.P.	Chiller Fluid Conn.	Weight Pounds
					Qty.	HP			Qty.	FLA ea.				
PZA1SE5	14,200	36	34	44	1	1.3	8.3	41	1	3.8	15	20	1"FPT	260
PZA1.5SE5	21,500	36	34	44	1	2.0	13.5	68	1	3.8	20	30	1"FPT	265
PZA1.5SF5							8.0	58		3.8	15	20		
PZA1.5SH5							4.2	29		1.5	15	15		
PZA1.5SI5							3.1	24		1.72	15	15		
PZA2SE5	24,100	36	34	44	1	2.5	14.1	75	1	3.8	25	35	1"FPT	265
PZA2SF5							9.9	73		3.8	20	25		
PZA2SH5							5.1	38		1.5	15	15		
PZA2SI5							3.8	28		1.72	15	15		
PZA2.5SE5	34,800	36	34	44	1	3.5	19.9	104	1	3.8	30	45	1"FPT	295
PZA2.5SF5							12.8	93		3.8	20	30		
PZA2.5SH5							5.8	48		1.5	15	15		
PZA2.5SI5							4.7	38		1.72	15	15		
PZA3SE5	39,200	36	34	44	1	4	21.8	137	1	3.8	35	50	1"FPT	490
PZA3SF5							15.4	114		3.8	25	35		
PZA3SH5							7.1	58		1.5	15	15		
PZA3SI5							5.2	43		1.72	15	10		
PZA4SE5	50,000	46	34	48	1	5	27.1	175	1	3.8	40	60	1"FPT	490
PZA4SF5							18.6	128		3.8	30	45		
PZA4SH5							8.0	63		1.5	15	15		
PZA4SI5							6.3	50		1.72	15	15		
PZA4.5SE5	54,000	46	34	48	1	5	25.0	129	1	3.8	40	60	1"FPT	500
PZA5SF5	60,000	46	34	48	1	6	18.6	156	1	3.8	30	45	1"FPT	500
PZA5SH5							10.3	75		1.5	15	20		
PZA5SI5							7.1	54		1.72	15	15		
PZA7SF5	81,000	75	34	50	1	8	28.8	195	2	3.8	45	70	1.25"FPT	650
PZA7SH5							14.7	95		1.5	25	35		
PZA7SI5							10.8	80		1.72	20	25		
PZA8SF5	91,000	75	34	50	1	9	30.1	225	2	3.8	50	70	1.25"FPT	650
PZA8SH5							15.5	114		1.5	25	35		
PZA8SI5							21.1	80		1.72	25	30		
PZA9SF5	106,000	75	34	50	1	10	37.2	239	2	3.8	60	90	1.25"FPT	690
PZA9SH5							17.2	125		1.5	25	40		
PZA9SI5							12.4	80		1.72	20	30		
PZA11SF5	132,000	75	34	50	1	12	49.4	300	2	3.8	70	110	1.25"FPT	750
PZA11SH5							23.1	150		1.5	35	50		
PZA11SI5							19.2	109		1.72	30	45		

1) The calculations for the MCA and MOP are based on requirements of NFPA 70, the National Electrical Code (NEC) and CSA C22.1, the Canadian Electrical Code (CEC). The MCA is the minimum wire size needed to guarantee that the wiring will not overheat under any operating conditions. The MOP is the maximum allowable circuit breaker size that will properly disconnect power to the equipment under any anticipated fault condition.

2) Weights are based on models with standard features only. Weights will increase with each added option. Consult factory.

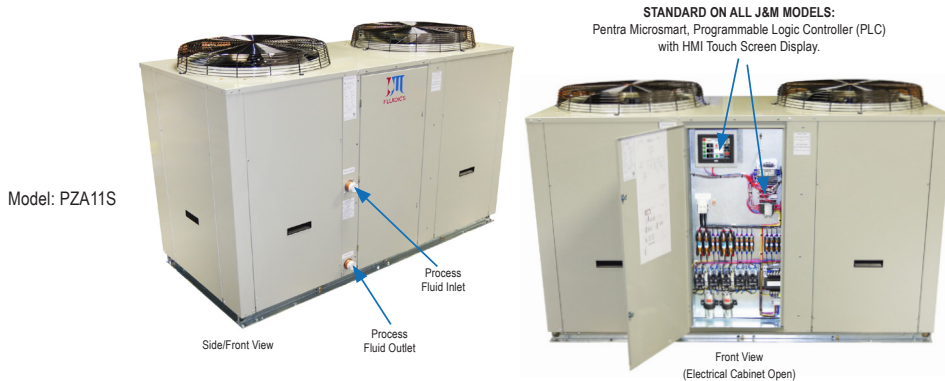

Dual Circuit Packaged, Air-Cooled Chillers



Chiller Model	BTUH 95°F Air 45°F LWT	Length Inches	Width Inches	Height Inches	Compressor		RLA ea.	LRA ea.	Fan Motor			Chiller Fluid Conn.	Weight Pounds	
					Qty.	HP			Qty.	FLA	MCA			M.O.P.
PZA7DE5	80,100	75	34	50	2	4	21.8	137	2	3.8	60	70	1.25"FPT	875
PZA7DF5							15.4	114		3.8	45	50		
PZA7DH5							7.1	58		1.5	20	25		
PZA7DI5							5.2	43		1.72	20	20		
PZA9DE5	106,400	75	34	50	2	5	27.1	175	2	3.8	70	90	1.25"FPT	900
PZA9DF5							18.6	128		3.8	50	60		
PZA9DH5							8.9	63		1.5	25	25		
PZA9DI5							6.3	50		1.72	20	20		
PZA9.5DE5	111,800	75	34	50	2	5	25.0	129	2	3.8	70	80	1.25"FPT	950
PZA10DF5	118,000	75	34	50	2	6	18.6	156	2	3.8	50	60	1.25"FPT	950
PZA10DH5							10.3	75		1.5	30	35		
PZA10DI5							7.1	54		1.72	20	25		
PZA13DF5	160,000	85	40	50	2	8	24.8	195	2	3.8	80	100	1.25"FPT	985
PZA13DH5							14.7	95		1.5	40	50		
PZA13DI5							10.8	80		1.72	30	35		
PZA15DF5	183,500	85	40	50	2	9	30.1	225	2	3.8	80	100	1.25"FPT	1000
PZA15DH5							15.5	114		1.5	40	50		
PZA15DI5							12.1	80		1.72	35	40		
PZA18DF5	209,200	85	40	50	2	10	37.2	239	2	3.8	100	125	1.5"FPT	1000
PZA18DH5							17.2	125		1.5	45	50		
PZA18DI5							12.4	80		1.72	35	40		
PZA22DF5	264,200	66	75	51	2	12	49.4	300	4	3.8	150	175	1.5"FPT	1150
PZA22DH5							23.1	150		1.5	60	80		
PZA22DI5							19.2	109		1.72	60	70		
PZA26DF5	302,000	176.5	45.5	55	2	15	53.8	340	2	7	150	200	2"MPT	3490
PZA26DH5							28.2	173		3.5	80	100		
PZA26DI5							22.4	132		2.8	70	80		
PZA35DF5	406,000	176.5	88	55	2	20	73.1	505	4	7	200	250	2"MPT	4800
PZA35DH5							30.1	225		3.5	90	110		
PZA35DI5							24.4	180		2.8	70	90		
PZA43DF5	500,000	176.5	88	55	2	25	89.7	500	4	7	250	300	2"MPT	4900
PZA43DH5							43.6	250		3.5	125	150		
PZA43DI5							32.7	198		2.8	90	110		
PZA52DF5	612,000	176.5	88	55	2	30	109	599	4	7	300	350	3"MPT	5200
PZA52DH5							53.2	310		3.5	150	175		
PZA52DI5							42.3	239		2.8	110	125		

1) The calculations for the MCA and MOP are based on requirements of NFPA 70, the National Electrical Code (NEC) and CSA C22.1, the Canadian Electrical Code (CEC). The MCA is the minimum wire size needed to guarantee that the wiring will not overheat under any operating conditions. The MOP is the maximum allowable circuit breaker size that will properly disconnect power to the equipment under any anticipated fault condition.

2) Weights are based on models with standard features only. Weights will increase with each added option. Consult factory.

STANDARD ON ALL J&M CHILLER MODELS:

Idc Microprocessor Controller with
Touch Screen Display.
(Located inside front electrical cabinet)

Model: PZA52D

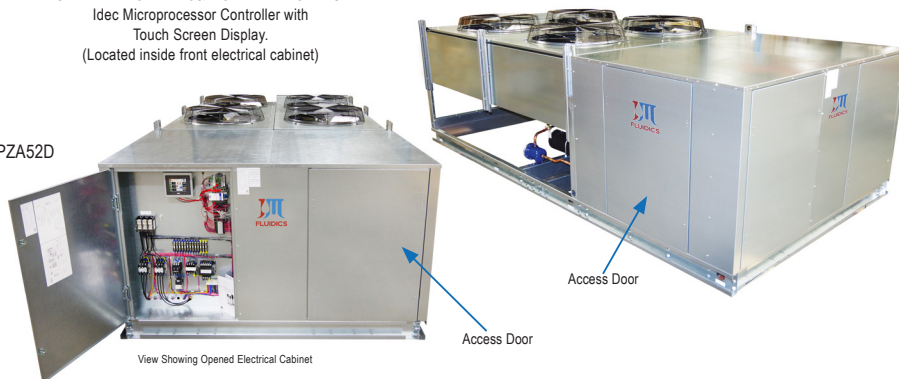

View Showing Opened Electrical Cabinet



Packaged, Air-Cooled Chillers with Stainless Steel Tank



Chiller Model	Nominal BTUH	Length Inches	Width Inches	Height Inches	Compressor		RLA Ea.	LRA Ea.	Fan Motor		Recirculation Pump FLA	MCA	M.O.P.	Reservoir Gal.	Chiller Fluid Conn	Weight Pounds
					Qty.	HP			Qty.	FLA ea.						
PZAT1SE5	14,000	36	34	68	1	1.3	8.3	40.3	1	3.8	4.2	20	25	20	1"FPT	550
PZAT1.5SE5	18,000	36	34	68	1	2.0	13.5	68	1	3.8	4.2	25	35	20	1"FPT	600
PZAT1.5SF5							8.0	58		3.8	4.2	20	25			
PZAT1.5SH5							4.2	29		1.5	0.9	15	15			
PZAT1.5SI5							3.1	24		1.72	0.72	15	15			
PZAT2SE5	22,000	36	34	68	1	2.5	14.1	75	1	3.8	4.2	30	40	20	1"FPT	650
PZAT2SF5							9.9	73		3.8	4.2	25	30			
PZAT2SH5							5.1	38		1.5	0.9	15	15			
PZAT2SI5							3.8	28		1.72	0.72	15	15			
PZAT2.5SE5	28,800	36	34	68	1	3.5	19.9	104	1	3.8	4.2	35	50	20	1"FPT	700
PZAT2.5SF5							12.8	93		3.8	4.2	25	35			
PZAT2.5SH5							5.8	48		1.5	0.9	15	15			
PZAT2.5SI5							4.7	38		1.72	0.72	15	15			
PZAT3SE5	36,000	36	34	68	1	4	21.8	137	1	3.8	4.2	40	50	20	1"FPT	800
PZAT3SF5							15.4	114		3.8	4.2	30	40			
PZAT3SH5							7.1	58		1.5	0.9	15	20			
PZAT3SI5							5.2	43		1.72	0.72	15	15			
PZAT4SE5	49,200	46	34	72	1	5	27.1	175	1	3.8	4.2	45	60	50	1"FPT	850
PZAT4SF5							18.6	128		3.8	4.2	35	45			
PZAT4SH5							8.0	63		1.5	0.9	15	20			
PZAT4SI5							6.3	50		1.72	0.72	15	15			
PZAT4.5SE5	51,600	46	34	72	1	5	25.0	129	1	3.8	4.2	40	60	50	1"FPT	875
PZAT5SF5							18.6	156		3.8	4.2	35	45			
PZAT5SH5							10.3	75		1.5	0.9	20	25			
PZAT5SI5							7.1	54		1.72	0.72	15	20			
PZAT7SF5	75,600	75	34	72	1	8	28.8	195	2	3.8	5.4	50	70	50	1"FPT	1100
PZAT7SH5							14.7	95		1.5	1.4	30	40			
PZAT7SI5							10.8	80		1.72	1	20	30			
PZAT8SF5							30.1	225		3.8	6.6	60	80			
PZAT8SH5	84,000	75	34	72	1	9	15.5	114	2	1.5	1.7	25	35	80	1.25"FPT	1150
PZAT8SI5							12.1	80		1.72	1.5	25	30			
PZAT9SF5							37.2	239		3.8	7.9	70	90			
PZAT9SH5							17.2	125		1.5	2.5	30	40			
PZAT9SI5	12.4	80	1.72	1.5	25	30										
PZAT11SF5	122,400	75	34	72	1	12	49.4	300	2	3.8	7.9	80	125	80	1.25"FPT	1300
PZAT11SH5							23.1	150		1.5	2.5	35	50			
PZAT11SI5							19.2	109		1.72	1.5	30	45			
PZAT7DE5							21.8	132		3.8	6.6	70	80			
PZAT7DF5	73,200	75	34	76	2	4	15.4	115	2	3.8	6.6	50	60	50	1.25"FPT	1100
PZAT7DH5							7.1	48		1.5	1.7	25	25			
PZAT7DI5							5.2	40		1.72	1	20	20			
PZAT9DE5							27.1	175		3.8	7.9	80	100			
PZAT9DF5	96,000	75	34	76	2	5	18.6	128	2	3.8	7.9	60	70	80	1.25"FPT	1200
PZAT9DH5							8.0	63		1.5	2.5	25	30			
PZAT9DI5							6.3	50		1.72	1.5	20	25			
PZAT9.5DE5							25.0	129		2	3.8	7.9	80			
PZAT10DF5	108,000	75	34	76	2	6	18.6	156	2	3.8	7.9	60	70	80	1.25"FPT	1250
PZAT10DH5							10.3	75		1.5	2.5	30	35			
PZAT10DI5							7.1	54		1.72	1.5	25	25			
PZAT13DF5							28.8	195		3.8	3.5	80	100			
PZAT13DH5	147,000	85	40	76	2	8	14.7	95	2	1.5	1.7	40	50	80	1.5"FPT	1300
PZAT13DI5							10.8	80		1.72	1.0	30	35			
PZAT15DF5							30.1	225		3.8	3.5	80	100			
PZAT15DH5							15.5	114		1.5	1.7	40	50			
PZAT15DI5	12.1	80	1.72	1.0	35	40										
PZAT18DF5	190,800	85	40	76	2	10	37.2	239	2	3.8	3.5	100	125	120	1.5"FPT	1450
PZAT18DH5							17.2	125		1.5	1.7	45	60			
PZAT18DI5							12.4	80		1.72	1.0	35	40			

1) The calculations for the MCA and MOP are based on requirements of NFPA 70, the National Electrical Code (NEC) and CSA C22.1, the Canadian Electrical Code (CEC). The MCA is the minimum wire size needed to guarantee that the wiring will not overheat under any operating conditions. The MOP is the maximum allowable circuit breaker size that will properly disconnect power to the equipment under any anticipated fault condition.

2) Weights are based on models with standard features only. Weights will increase with each added option. Consult factory.



Split-System, Air-Cooled Chillers

Chiller Model	Nominal BTUH	Length Inches	Width Inches	Height Inches	Compressor		RLA ea.	LRA ea.	Fan Motor		MCA	M.O.P.	Chiller Fluid Conn	Weight Pounds	Condenser Selection
					Qty.	HP			Qty.	FLA ea.					
IEZA1SE5	14,200	44	28	36	1	1.3	8.3	40.3	1	3.8	15	20	1"FPT	225	OC1S
IEZA1.5SE5	21,500	44	28	36	1	2.0	13.5	68	1	3.8	20	30	1"FPT	225	OC1.5S
IEZA1.5SF5							8.0	58		3.8	15	20			
IEZA1.5SH5							4.2	29		1.5	15	15			
IEZA1.5SI5							3.1	24		1.72	15	15			
IEZA2SE5	24,100	44	28	36	1	2.5	14.1	75	1	3.8	25	35	1"FPT	370	OC2S
IEZA2SF5							9.9	73		3.8	20	25			
IEZA2SH5							5.1	38		1.5	15	15			
IEZA2SI5							3.8	28		1.72	15	15			
IEZA2.5SE5	34,800	44	28	36	1	3.5	19.9	104	1	3.8	30	45	1"FPT	500	OC2.5S
IEZA2.5SF5							12.8	93		3.8	20	30			
IEZA2.5SH5							5.8	48		1.5	15	15			
IEZA2.5SI5							4.7	38		1.72	15	15			
IEZA3SE5	39,200	44	28	36	1	4	21.8	137	1	3.8	35	50	1"FPT	500	OC3S
IEZA3SF5							15.4	114		3.8	25	35			
IEZA3SH5							7.1	58		1.5	15	15			
IEZA3SI5							5.2	43		1.72	15	15			
IEZA4SE5	50,000	44	28	36	1	5	27.1	175	1	3.8	40	60	1"FPT	550	OC4S
IEZA4SF5							18.6	128		3.8	30	45			
IEZA4SH5							8.0	63		1.5	15	20			
IEZA4SI5							6.3	50		1.72	15	15			
IEZA4.5SE5	54,000	44	28	36	1	5	25.0	129	1	3.8	40	60	1"FPT	575	OC4.5S
IEZA5SF5	60,000	44	28	36	1	6	18.6	156	1	3.8	30	45	1"FPT	600	OC5S
IEZA5SH5							10.3	75		1.5	15	20			
IEZA5SI5							7.1	54		1.72	15	15			
IEZA7SF5	81,000	44	28	36	1	8	28.8	195	2	3.8	45	70	1"FPT	700	OC7S
IEZA7SH5							14.7	95		1.5	25	35			
IEZA7SI5							10.8	80		1.72	20	25			
IEZA8SF5	91,000	44	28	36	1	9	30.1	225	2	3.8	50	70	1.25"FPT	725	OC8S
IEZA8SH5							15.5	114		1.5	25	35			
IEZA8SI5							12.1	80		1.72	25	30			
IEZA9SF5	106,000	44	28	36	1	10	37.2	239	2	3.8	60	90	1.25"FPT	750	OC9S
IEZA9SH5							17.2	125		1.5	25	40			
IEZA9SI5							12.4	80		1.72	20	30			
IEZA11SF5	132,000	44	28	36	1	12	49.4	300	2	3.8	70	110	1.25"FPT	850	OC11S
IEZA11SH5							23.1	150		1.5	35	50			
IEZA11SI5							19.2	109		1.72	30	45			

1) The calculations for the MCA and MOP are based on requirements of NFPA 70, the National Electrical Code (NEC) and CSA C22.1, the Canadian Electrical Code (CEC). The MCA is the minimum wire size needed to guarantee that the wiring will not overheat under any operating conditions. The MOP is the maximum allowable circuit breaker size that will properly disconnect power to the equipment under any anticipated fault condition.

2) Weights are based on models with standard features only. Weights will increase with each added option. Consult factory.

3) See Installation Instruction Manual Refrigerant Chart for additional refrigerant charge needed for extended pipe length.

4) See condenser specification sheet for weight and dimension.



Model Shown:
IEZA10DF5

Split-System, Air-Cooled Chillers

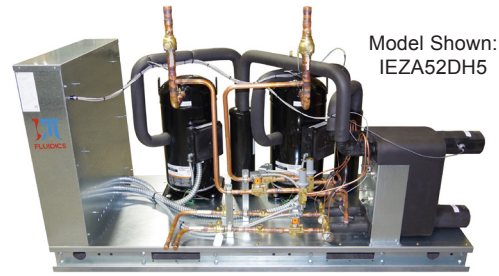

Model Shown:
IEZA52DH5

Chiller Model	Nominal BTUH	Length Inches	Width Inches	Height Inches	Compressor		RLA ea.	LRA ea.	Fan Motor		MCA	M.O.P.	Chiller Fluid Conn	Weight Pounds	Condenser Selection
					Qty.	HP			Qty.	FLA ea.					
IEZA7DE5	80,100	65	30	37	2	4	21.8	137	2	3.8	60	70	1.25"FPT	900	OC7D
IEZA7DF5							15.4	114		3.8	45	50			
IEZA7DH5							7.1	58		1.5	20	25			
IEZA7DI5							5.2	40		1.72	20	20			
IEZA9DE5	106,400	65	30	37	2	5	27.1	175	2	3.8	70	90	1.25"FPT	1000	OC9D
IEZA9DF5							18.6	128		3.8	50	60			
IEZA9DH5							8.0	63		1.5	25	25			
IEZA9DI5							6.3	50		1.72	20	20			
IEZA9.5DE5	111,800	65	30	37	2	5	25.0	129	2	3.8	70	80	1.25"FPT	1100	OC9.5D
IEZA10DF5	118,000	65	30	37	2	6	18.6	156	2	3.8	50	60	1.25"FPT	1200	OC10D
IEZA10DH5							10.3	75		1.5	30	35			
IEZA10DI5							7.1	54		1.72	20	25			
IEZA13DF5	160,000	65	30	37	2	8	28.8	195	2	3.8	80	100	1.25"FPT	1400	OC13D
IEZA13DH5							14.7	95		1.5	40	50			
IEZA13DI5							10.8	80		1.72	30	35			
IEZA15DF5	183,500	65	30	37	2	9	30.1	225	2	3.8	80	100	1.25"FPT	1450	OC15D
IEZA15DH5							15.5	114		1.5	40	40			
IEZA15DI5							12.1	80		1.72	35	45			
IEZA18DF5	209,200	65	30	37	2	10	37.2	239	2	3.8	100	125	1.5"FPT	1450	OC18D
IEZA18DH5							17.2	125		1.5	45	50			
IEZA18DI5							12.4	80		1.72	35	40			
IEZA22DF5	264,200	65	30	37	2	12	49.4	300	4	3.8	150	175	1.5"FPT	1750	OC22D
IEZA22DH5							23.1	150		1.5	60	80			
IEZA22DI5							19.2	109		1.72	60	70			
IEZA26DF5	302,000	85	34	42	2	15	53.8	340	2	7	150	200	2"MPT	1500	BNH217
IEZA26DH5							28.2	173		3.5	80	100			
IEZA26DI5							22.4	132		2.8	70	80			
IEZA35DF5	406,000	85	34	42	2	20	73.1	505	4	7	200	250	2.5"MPT	1600	BNH421
IEZA35DH5							30.1	225		3.5	90	110			
IEZA35DI5							24.4	180		2.8	70	90			
IEZA43DF5	500,000	85	34	42	2	25	89.7	500	4	7	250	300	2"MPT	1700	BNH429
IEZA43DH5							43.6	250		3.5	125	150			
IEZA43DI5							32.7	198		2.8	90	110			
IEZA52DF5	612,000	85	34	42	2	30	109	599	4	7	300	350	2.5"MPT	1700	BNH434
IEZA52DH5							53.2	310		3.5	150	175			
IEZA52DI5							42.3	239		2.8	110	125			

1) The calculations for the MCA and MOP are based on requirements of NFPA 70, the National Electrical Code (NEC) and CSA C22.1, the Canadian Electrical Code (CEC). The MCA is the minimum wire size needed to guarantee that the wiring will not overheat under any operating conditions. The MOP is the maximum allowable circuit breaker size that will properly disconnect power to the equipment under any anticipated fault condition.

2) Weights are based on models with standard features only. Weights will increase with each added option. Consult factory.



Shown:
IEZA91M Custom
Split-System Chiller
in testing stages
with the outdoor
condenser.

Split-System, Single Circuit Air-Cooled Chillers - *with Tank*



Chiller Model	Nominal BTUH	Length Inches	Width Inches	Height Inches	Compressor		RLA Ea.	LRA Ea.	Fan Motor		Recirculation Pump FLA	MCA	M.O.P.	Reservoir Gal.	Chiller Fluid Conn.	Weight Pounds	Condenser Model				
					Qty.	HP			Qty.	FLA											
IEZAT1SE5	14,000	36	34	65	1	1.3	8.3	40.3	1	3.8	4.2	20	25	20	1" FPT	550	OC1S				
IEZAT1.5SE5	18,000	36	34	65	1	2.0	13.5	68	1	3.8	4.2	25	35	20	1" FPT	600	OC1.5S				
IEZAT1.5SF5							8.0	58										3.8	4.2	20	25
IEZAT1.5SH5							4.2	29										1.5	0.9	15	15
IEZAT1.5SI5							3.1	24										1.72	0.72	15	15
IEZAT2SE5	22,000	36	34	65	1	2.5	14.1	75	1	3.8	4.2	30	40	20	1" FPT	650	OC2S				
IEZAT2SF5							9.9	73										3.8	4.2	25	30
IEZAT2SH5							5.1	38										1.5	0.9	15	15
IEZAT2SI5							3.8	28										1.72	0.72	15	15
IEZAT2.5SE5	28,800	36	34	65	1	3.5	19.9	104	1	3.8	4.2	35	50	20	1" FPT	700	OC2.5S				
IEZAT2.5SF5							12.8	93										3.8	4.2	25	35
IEZAT2.5SH5							5.8	48										1.5	0.9	15	15
IEZAT2.5SI5							4.7	38										1.72	0.72	15	15
IEZAT3SE5	36,000	36	34	65	1	4	21.8	137	1	3.8	4.2	40	60	20	1" FPT	800	OC3S				
IEZAT3SF5							15.4	114										3.8	4.2	30	40
IEZAT3SH5							7.1	58										1.5	0.9	15	20
IEZAT3SI5							5.2	43										1.72	0.72	15	15
IEZAT4SE5	49,200	46	34	69	1	5	27.1	175	1	3.8	4.2	45	60	50	1" FPT	850	OC4S				
IEZAT4SF5							18.6	128										3.8	4.2	35	45
IEZAT4SH5							8.0	63										1.5	0.9	15	20
IEZAT4SI5							6.3	50										1.72	0.72	15	15
IEZAT4.5SE5	51,600	46	34	69	1	5	25.0	129	1	3.8	4.2	40	60	50	1" FPT	875	OC4.5S				
IEZAT5SF5	55,200	46	34	69	1	6	18.6	156	1	3.8	4.2	35	45	50	1" FPT	900	OC5S				
IEZAT5SH5							10.3	75										1.5	0.9	20	25
IEZAT5SI5							7.1	54										1.72	0.72	15	20
IEZAT7SF5							28.8	195										3.8	5.4	50	70
IEZAT7SH5	75,600	75	34	70	1	8	14.7	95	2	1.5	1.4	30	40	50	1" FPT	1100	OC7S				
IEZAT7SI5							10.8	80										1.72	1	20	25
IEZAT8SF5	84,000	75	34	70	1	9	30.1	225	2	3.8	6.6	60	80	80	1.25" FPT	1150	OC8S				
IEZAT8SH5							15.5	114										1.5	1.7	25	35
IEZAT8SI5							12.1	80										1.72	1.5	25	30
IEZAT9SF5							37.2	239										3.8	7.9	70	90
IEZAT9SH5	98,400	75	34	70	1	10	17.2	125	2	1.5	2.5	30	40	80	1.25" FPT	1250	OC9S				
IEZAT9SI5							12.4	80										1.72	1.5	25	30
IEZAT11SF5	122,400	75	34	70	1	12	49.4	300	2	3.8	7.9	80	125	80	1.25" FPT	1300	OC11S				
IEZAT11SH5							23.1	150										1.5	2.5	35	50
IEZAT11SI5							19.2	109										1.72	1.5	30	45

1) The calculations for the MCA and MOP are based on requirements of NFPA 70, the National Electrical Code (NEC) and CSA C22.1, the Canadian Electrical Code (CEC). The MCA is the minimum wire size needed to guarantee that the wiring will not overheat under any operating conditions. The MOP is the maximum allowable circuit breaker size that will properly disconnect power to the equipment under any anticipated fault condition.

2) Weights are based on models with standard features only. Weights will increase with each added option. Consult factory.

3) See Installation Instruction Manual Refrigerant Chart for additional refrigerant charge needed for extended pipe length.

4) See condenser specification sheet for weight and dimension.



Split-System, Dual Circuit Air-Cooled Chillers - *with Tank*

Chiller Model	Nominal BTUH	Length Inches	Width Inches	Height Inches	Compressor		RLA	LRA	Fan Motor		Recirculation Pump FLA	MCA	M.O.P.	Reservoir Gal.	Chiller Fluid Conn.	Weight Pounds	Condenser Model
					Qty.	HP	Ea.	Ea.	Qty.	FLA							
IEZAT7DE5	73,200	75	34	70	2	4	21.8	137	2	3.8	6.6	70	80	50	1.25" FPT	1350	OC7D
IEZAT7DF5							15.4	114		3.8	6.6	50	60				
IEZAT7DH5							7.1	58		1.5	1.7	25	25				
IEZAT7DI5							5.2	43		1.72	1	20	20				
IEZAT9DE5	96,000	75	34	70	2	5	27.1	175	2	3.8	7.9	80	100	80	1.25" FPT	1400	OC9D
IEZAT9DF5							18.6	128		3.8	7.9	60	70				
IEZAT9DH5							8.0	63		1.5	2.8	25	30				
IEZAT9DI5							6.3	50		1.72	2.5	20	25				
IEZAT9.5DE5	102,000	75	34	70	2	5	25.0	129	2	3.8	7.9	80	90	80	1.25" FPT	1450	OC9.5D
IEZAT10DF5	108,000	75	34	70	2	6	18.6	156	2	3.8	7.9	60	70	80	1.25" FPT	1500	OC10D
IEZAT10DH5							10.3	75		1.5	2.5	30	35				
IEZAT10DI5							7.1	54		1.72	1.5	25	25				
IEZAT13DF5	147,000	75	34	70	2	8	28.8	195	2	3.8	3.5	80	100	80	1.5" FPT	1700	OC13D
IEZAT13DH5							14.7	95		1.5	1.7	40	50				
IEZAT13DI5							10.8	80		1.72	1.0	30	35				
IEZAT15DF5	167,000	85	34	70	2	9	30.1	225	2	3.8	3.5	80	100	80	1.5" FPT	1800	OC15D
IEZAT15DH5							15.5	114		1.5	1.7	40	50				
IEZAT15DI5							12.1	80		1.72	1.0	35	40				
IEZAT18DF5	190,800	85	34	70	2	10	37.2	239	2	3.8	3.5	100	125	120	1.5" FPT	1900	OC18D
IEZAT18DH5							17.2	125		1.5	1.7	45	60				
IEZAT18DI5							12.4	80		1.72	1.0	35	40				
IEZAT22DF5	238,800	85	34	70	2	12	49.4	300	4	3.8	5.6	125	150	120	1.5" FPT	2100	OC22D
IEZAT22DH5							23.1	150		1.5	2.8	60	70				
IEZAT22DI5							19.2	109		1.72	2.3	60	70				

1) The calculations for the MCA and MOP are based on requirements of NFPA 70, the National Electrical Code (NEC) and CSA C22.1, the Canadian Electrical Code (CEC). The MCA is the minimum wire size needed to guarantee that the wiring will not overheat under any operating conditions. The MOP is the maximum allowable circuit breaker size that will properly disconnect power to the equipment under any anticipated fault condition.

2) Weights are based on models with standard features only. Weights will increase with each added option. Consult factory.



Model Shown:
OC52DH5

R407C Split-System Outdoor Condenser

Model	Length Inches	Width Inches	Height Inches	Fan Motor		Refrigerant Conn.		Weight Pounds
				Qty	HP	Discharge	Liquid	
OC1S	36	34	40	1	1/2	1/2"	3/8"	125
OC1.5S	36	34	40	1	1/2	1/2"	3/8"	135
OC2S	36	34	40	1	1/2	1/2"	3/8"	145
OC2.5S	36	34	40	1	1/2	1/2"	3/8"	200
OC3S	46	34	47	1	1/2	5/8"	1/2"	205
OC4S	46	34	47	1	1/2	3/4"	1/2"	225
OC4.5S	46	34	47	1	1/2	3/4"	1/2"	235
OC5S	46	34	47	1	1/2	3/4"	1/2"	235
OC7S	75	34	47	2	1/2	7/8"	1/2"	355
OC8S	75	34	47	2	1/2	7/8"	5/8"	355
OC9S	75	34	47	2	1/2	7/8"	5/8"	355
OC11S	75	34	47	2	1/2	1 1/8"	5/8"	400
OC7D	75	34	47	2	1/2	5/8" (2)	1/2" (2)	515
OC9D	75	34	47	2	1/2	3/4" (2)	1/2" (2)	535
OC9.5D	75	34	47	2	1/2	3/4" (2)	1/2" (2)	655
OC10D	75	34	47	2	1/2	3/4" (2)	1/2" (2)	655
OC13D	85	40	47	2	1/2	7/8" (2)	1/2" (2)	745
OC15D	85	40	47	2	1/2	7/8" (2)	5/8" (2)	745
OC18D	85	40	47	2	1/2	7/8" (2)	5/8" (2)	745
OC22D	66	75	49	4	1/2	1 1/8" (2)	5/8" (2)	1025
OC26D	127	46	49	2	1 1/2	1 1/8" (2)	5/8" (2)	680
OC35D	127	88	49	4	1 1/2	1 3/8" (2)	7/8" (2)	1240
OC43D	127	88	49	4	1 1/2	1 3/8" (2)	7/8" (2)	1340
OC52D	127	88	49	4	1 1/2	1 5/8" (2)	1 1/8" (2)	1440

OC1S, 1.5S, 2S, 2.5S

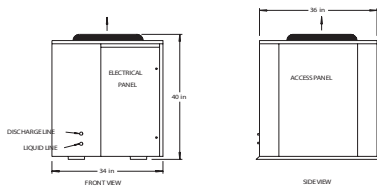

OC3S, 4S, 4.5S, 5S

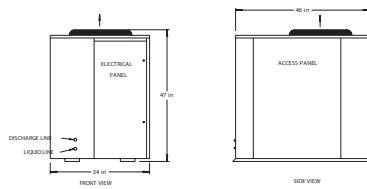

OC7S, 8S, 9, 11S, 7D, 9D, 9.5D, 10D

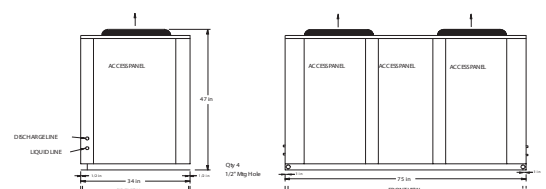

OC26D

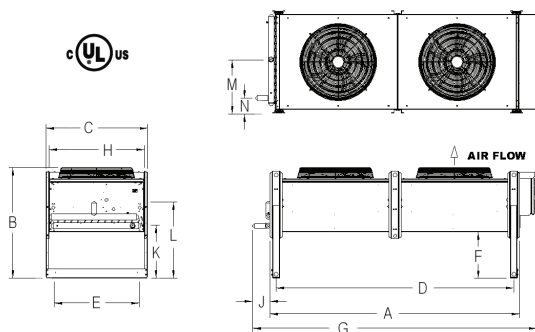

OC35D, 43D, 52D

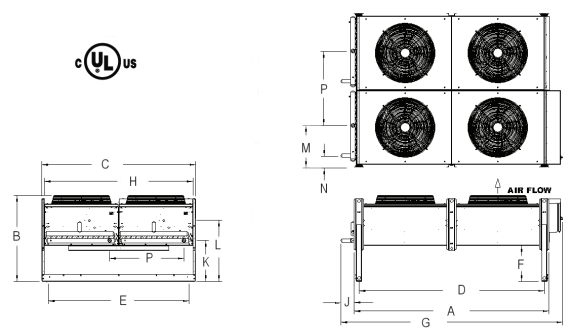

Dimensional Specifications, Features and Options

Polyethylene Tank & Pump

TANK MODEL	LENGTH IN.	WIDTH IN.	HEIGHT IN.	WATER CONN.	TANK CAPACITY	RECIRCULATION PUMP	FLA 230/3Ø	FLA 460/3Ø	WEIGHT LBS.
RRT200	88	56	60	2" FPT	200 GALLONS	3HP	9.4	4.5	445
RRT300	88			2.5" FPT	300 GALLONS	3HP	9.4	4.5	465
RRT500	120			3" FPT	500 GALLONS	5HP	13.7	6.5	595
RRT600	120			4" FPT	600 GALLONS	5HP	13.7	6.5	625

Stainless Steel Tank & Pump

TANK MODEL	LENGTH IN.	WIDTH IN.	HEIGHT IN.	WATER CONN.	TANK CAPACITY	RECIRCULATION PUMP	FLA 230/3Ø	FLA 460/3Ø	WEIGHT LBS.
RRT20-SS	36	34	36	1" FPT	20 GALLONS	1/2HP	2.6	1.3	475
RRT50-SS	46			1" FPT	50 GALLONS	1/2HP	2.6	1.3	525
RRT80-SS	75			1 1/4" FPT	80 GALLONS	3/4HP	3.5	1.7	600
RRT120-SS	85			1 1/2" FPT	120 GALLONS	1 1/2HP	5.6	2.8	675

(Stainless Steel Tank) Standard Features:

- **STAINLESS STEEL** storage tank
- 20, 50, 80, & 120 gallon tank sizes
- 1/2" tank and fluid piping insulator
- Copper fluid piping
- Tank vent and drain connections
- Tank pressure relief valve
- Fused evaporator fluid re-circulating **STAINLESS STEEL** pump
- Fluid pump discharge ball valve and cleanable "Y" strainer
- Control box with pump terminal block
- Painted (Powder Coated), galvanized sheet metal cabinet



(Stainless Steel Inside Tank)
Model: RST120H

Available Options:

- Fused, **STAINLESS STEEL** process pump
- Dual process pump with manual changeover
- Dual process pump with auto changeover
- Pump suction isolation valve
- **Process Pump VFD Controller**
- **Tank fluid sight glass**
- Tank liquid level indicator with dry contacts
- Low flow by-pass valve
- **Water flow meter**
- Auto city water make up solenoid
- Stainless steel, SCH80 PVC or Polypropylene piping for de-ionized and reverse osmosis water systems
- 1" tank and piping insulation in lieu of 1/2"
- Seal-tight electrical conduit and connections

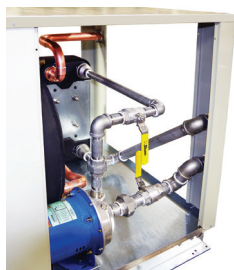

Shown Below:
Model: RST120H,
with Stainless Steel
Piping inside

(Polyethylene Tank) Standard Features:

- Open Vented **Polyethylene tank**
- **200, 300, 500, & 600 gallon open-vented tank sizes**
- 1/2" tank and fluid piping insulation
- SCH80 PVC and Polypropylene piping
- Fused evaporator fluid re-circulating **STAINLESS STEEL** pump
- Chiller evaporator pump discharge ball valve and cleanable "Y" strainer
- Control box with pump terminal block
- Galvanized steel sheet metal cabinet
- Hinged removable access panels



(Polyethylene Tank)
600 Gallon Tank & Pump
Package with
Dual Process Pumps

Available Options:

- Fused, **STAINLESS STEEL** process pump
- Dual process pump with manual changeover
- Dual process pump with auto changeover
- Pump suction isolation valve
- **Process Pump VFD Controller**
- **Tank fluid sight glass**
- Tank liquid level indicator with dry contacts
- Low flow by-pass valve
- **Water flow meter**
- Auto city water make up solenoid
- 1" tank and piping insulation in lieu of 1/2"
- Seal-tight electrical conduit and connections



Inside View:
Model: RRT600H,
Dual Vertical 10 HP
Process Pumps

R407C Packaged, Air-Cooled Chillers

PZA1S, 1.5S, 2S, 2.5S, 3S, 4S, 4.5S, 5S

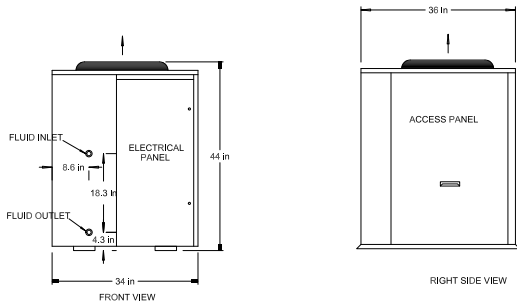

PZA7S, 8S, 9S, 11S, 7D, 9D, 9.5D, 10D

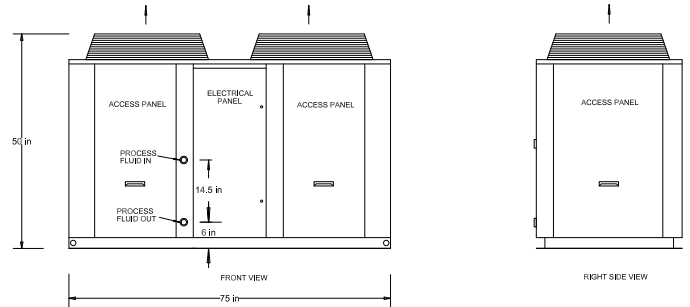

PZA13D, 15D, 18D

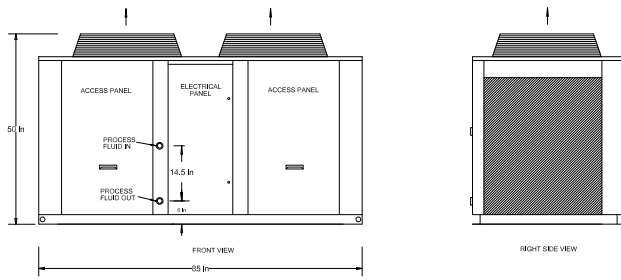

PZA22D (four fans)

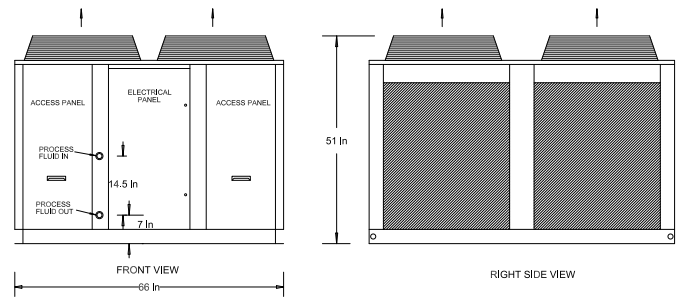

PZAT1S, 1.5S, 2S, 2.5S, 3S, 4S, 4.5S, 5S

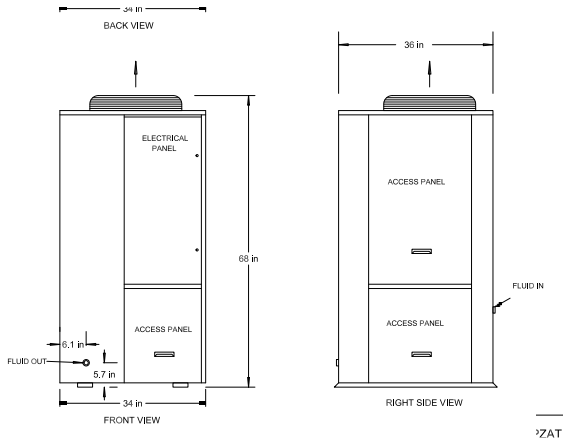

PZAT7S, 8S, 9S, 11S, 7D, 9D, 9.5D, 10D

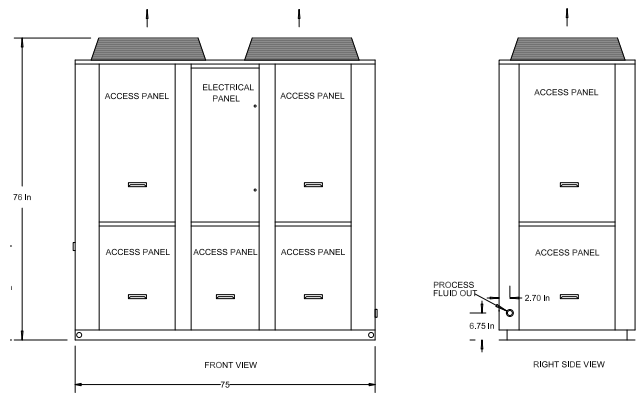

PZAT13D, 15D, 18D

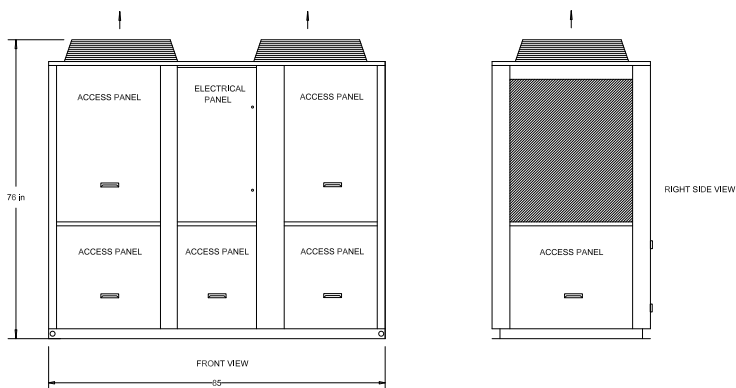

PZA35D, 43D, 52D

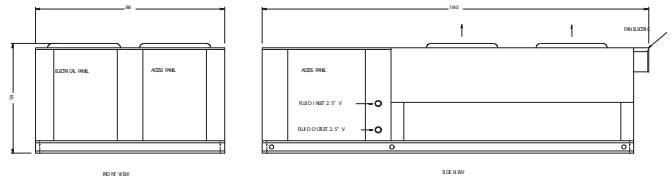

PROPYLENE GLYCOL CAPACITY CORRECTION FACTOR TABLE							
PERCENT PROPYLENE GLYCOL BY WEIGHT	15%	20%	25%	30%	35%	40%	50%
FREEZING POINT IN °F	24	18	15	9	5	-5	-30
CAPACITY FACTOR MULTIPLIER*	0.992	0.986	0.972	0.960	0.950	0.928	0.878
PRESSURE DROP MULTIPLIER	1.04	1.08	1.13	1.21	1.26	1.47	2.79
ETHYLENE GLYCOL CAPACITY CORRECTION FACTOR TABLE							
PERCENT ETHYLENE GLYCOL BY WEIGHT	10%	15%	20%	25%	30%	35%	40%
FREEZING POINT IN °F	25	21	17	11	5	0	-10
CAPACITY FACTOR MULTIPLIER*	0.98	0.96	0.95	0.93	0.92	0.91	0.89
PRESSURE DROP MULTIPLIER	1.08	1.11	1.16	1.21	1.27	1.32	1.38

* At standard ARI 590 conditions: 54°F entering fluid temperature, 44°F leaving fluid temperature, 95°F ambient temperature, 0.0005 fouling.

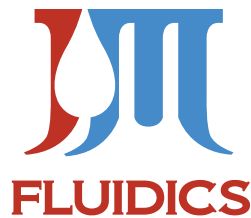

*It's All about Building a
Better Product for Our Clients!*

Have Questions? Give Us a Call at: **888-539-1731**

Email: info@jmchillers.com

Website: www.jmchillers.com

